

Reason to choose NEW CORDLESS DIGITAL LAMP

- (1) Stable and super bright.
- (2) Small size, light weight and portable design.
- (3) OLED screen can display a variety of content.
- (4) Magnetic USB wire charging.
- (5) Adjustable lighting angle.
- (6) Safe, reliable and maintenance-free.
- (7) More options of different models.
- (8) Explosion-proof and super impact-resistance.
- (9) Super water proof.
- (10) Environmentally-friendly .
- (11) Longer life span.

NEW CORDLESS DIGITAL LAMP

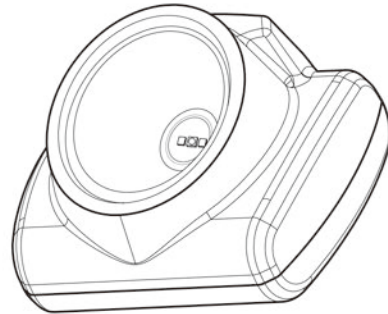

Product Description

TABLE OF CONTENTS

Features	1
Technical Specification	3
Parts	4
Dimension	5
Use Guide	6
Trouble And Troubleshooting.....	10
Notes.....	10
Safety Warning.....	10
Package.....	11

► FEATURES

This new cordless digital lamp is perfectly created with industrial design, electronic and software design, production design. Compared to the traditional cordless headlights, it is added OLED screen to display time, power and some texts contents. This lamp has strong brightness, IP68 waterproof, long duration, small size and light weight etc. And it can be used for home lighting and some outdoor lighting, such as camping, biking, hiking, climbing, construction, fishing etc. Meanwhile, it is able to withstand the harshest underground condition, such as the coal mine and metal mines and other underground sites. The significant features are as the follows:

1. 100000 hours lifespan and super stable brightness

LED lifespan depends on the quality of LED and the driving power, this new cordless cap lamp applies CREE LED and advanced driver, and its life span is up to 100000 hours. With exact design of the reflecting cup, the brightness of this lamp reaches 16000 LUX illumination which is the highest brightness in this kind of lamp.

2. OLED Display the battery power display

This new cordless digital lamp applies OLED display technology, allows you to easily grasp the time and remaining power. OLED screen is an active light emitting display, high contrast, wide visual angle (up to 170°), fast response, high efficiency, low operating voltage (3-10V), ultra thinness (less than 2mm). This screen can display time and battery capacity to keep you have a convenient use during the outdoor activities. And we can also edit some text informations to be displayed in the screen such as company logo, starting words or other information which you need to display to the user. It improves the feeling to the users.

3. Safety reliable and free maintenance

This new cordless digital lamp uses 2pcs 18650 Lithium batteries which can keep the lamp more than 13 hours continuous working time. The motherboard is designed with short-circuit, over-charging, over-discharging protection. And it is also high temperature and low temperature resistant. It is also water-proof, anti-explosive proof to keep reliable and safety use.

4. Explosion-proof and Strong impact resistance

The housing of this new cordless cap lamp is made of high strength PC. The internal structure of excellent design ensures the strength of the shell and the reduction of the internal stress, which makes the product have a stronger impact resistance and durability.

5. Super waterproof

This new cordless digital lamp applies the professional waterproof design which enable to approve IP68 testing.

6. Low battery power alarm

When the battery voltage is below 3.4-3.2V, and the battery capacity is less than 15-20%, the auxiliary lights will flash to warn the user for charging, and then the main lighting will transfer to auxiliary lighting automatically.

7. SOS function

This new cordless digital lamp can be used as a distress signal light during working, and we can write a distress signal according to customer requirements.

8. Convenient charging way with USB

This new cordless digital lamp breaks through the traditional way of charging, with magnetic USB charging. You can charge the lamp in somewhere with USB connector conveniently. The charger is also connected with strong brass magnetic connector which is water-proof and good conductivity.

9. SUPER-LIGHT in WEIGHT

This new cordless digital lamp is just 140g-198g, light weight as a cell phone. It is more portable than traditional cordless lamp.

10. Environmentally friendly

This new cordless digital cap lamp is strictly followed during the whole process, from material selection to control process.

► TECHNICAL SPECIFICATION OF NEW CORDLESS DIGITAL LAMP

Features	Specification		
Model	KL6-A	KL6-B	KL6-C
Rated capacity	3.1Ah	5.2Ah	6.2Ah
Rated voltage	3.7V		
Continuous working time	≥ 13h	≥ 15h	≥ 20h
Main light LED working voltage	3.0V		
Main light LED working current	220mA	300mA	300mA
Main light power	1W		
Main light luminous flux	129Lum		
Lamp lighting degree (initial degree at 1m)	6000lux	15000lux	15000lux
Auxiliary light power	0.4W		
Main light life span	≥ 5000h		
life span of the battery	1200cycles		
Charging time	3.5h	4h	6h
Dimension	85*72*24mm		
Weight	140g	198g	198g

► PARTS OF NEW CORDLESS DIGITAL LAMP

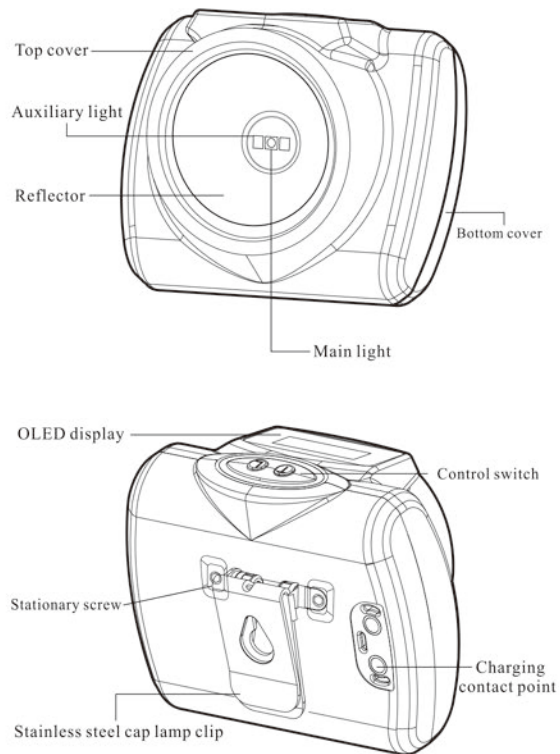

•Standard accessories



Lamp



Power adaptor

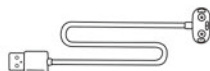

Magnetic USB charger wire



Vehicle power adaptor

► DIMENSION OF NEW CORDLESS DIGITAL LAMP

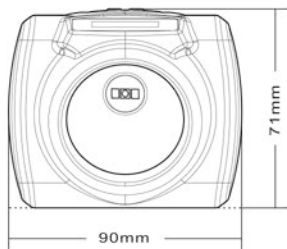

The main view



The left view

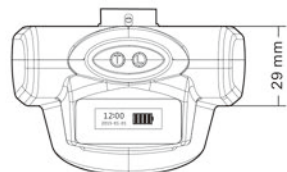

The right view

5

► USE GUIDE OF NEW CORDLESS DIGITAL LAMP

•USB Charging Way

Connect the “5V, 2A” power supply with magnetic USB line to “AC, 100-240V” outlet. The charger indicator turns green, as following :

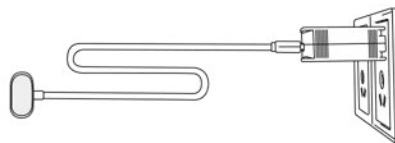

Connect the magnetic charging terminal with USB charging points make them contact tightly. The lamp's indicator turns red, which means it's charging.

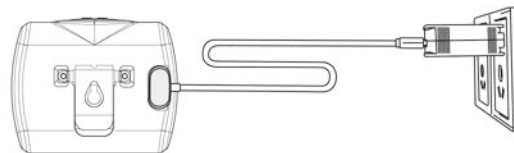



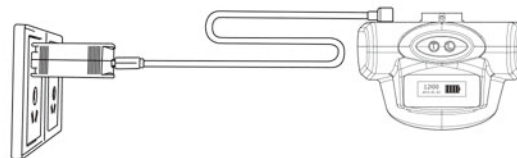

The OLED screen displays the battery charging and discharging status, and the battery capacity level during charging and working. When the lamp is charging, the OLED screen displays battery full, you can take off the magnetic USB charging cable. If the OLED screen display there is just one square power, you need to charge the lamp.



6

•Charging indication function

Charging stage	Status of charging indicator
Battery capacity <1/4	
1/4 < battery capacity < 1/2	
1/2 < battery capacity < 3/4	
3/4 < battery capacity < Fully	

•Switch

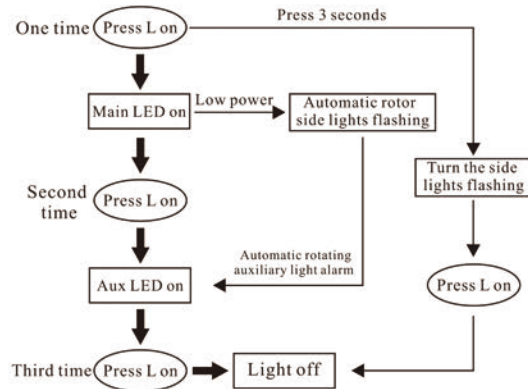

7

•Light operating instructions

1.Normal service operation

Short press the L button one time ,main light work;Short press L button second times ,secondary light work;Short press the button third times L button, all light off.

2.SOS function

Long press button; L 3 seconds, flashing regularly(0.1 seconds on , 0.1S off, so the cycle, according to the SOS distress signal settings)

3.The process of charging display

Low battery charging LCD will often bright, automatically extinguished after 3 minutes, until after full LCD again constant light automatically turns off in 3 minutes.The charging process if the LCD does not display, press any key to LCD can be bright.

•Time modulation instructions

Long press T clock modulation and Automatic arc screen time modulation

1. Clock modulation: Long press T button for more than 2 seconds, enter the clock setting mode;Short press the button one time T, the corresponding numerical automatically add one, enter the next value is set (object is debugging will flash beat), long press button T again for 2 seconds or more exit clock setting mode.

2. Automatic arc screen time modulation: Long press T button for more than 2 seconds, enter the clock setting mode;Short press the button eight times L, into the automatic arc screen time setting, Short press the button one time T, the corresponding numerical automatically add one, Short press the button L at a time, into the next value is set, long press button T again for 2 seconds or more exit clock setting mode.

3. Press the T/L button at the same time, the screen automatically extinguished.

•Install cap lamp clip

Put the rotatable cap lamp onto the positioning slot, and then fix the rotatable cap lamp clip clockwise with the hex-screwdriver.

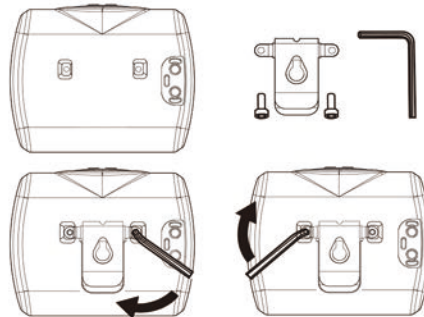

8

•Lighting angle adjustment & Usage

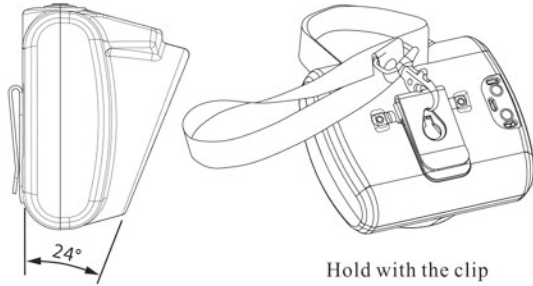

- You can use the belt to hold the lamp for more convenient usage.

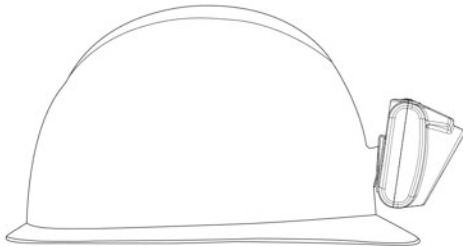

Miner's lamp

- You can not only the lamp on cap with the clip, but also put it on the wall by hanging it on a nail with a strap.

► TROUBLE AND TROUBLESHOOTING

Trouble description	Trouble analysis	Troubleshooting
Light is not on when pressing the button	Battery power is used up or Automatic opening protection	Charge the lamp
Working time is less than 12 hours	Battery is not fully charged	Make sure the lamp well connected to the charger when charging.
Longer charging time	The charging points poor contact	Clean the charging points and the slot
Low illuminance	Dirty lens	Clean water wash lens

► NOTES

- The lamp is half charged before delivery, please fully charge it before using.
- Please use our own matched charger/charging rack or magnetic USD wire to charge the multi-purpose lamp, or the lamp may be damaged.
- If the lamps need storing for a long period, please repeat the following maintenance steps every two months: fully charged → completely discharged → charged for 2 hour.
- Please clean up the dust in the charging point slot timely for the normal charging with the USB wire.

► SAFETY WARNING

- Please don't shoot at eyes directly while the lamp is working since the strong light will hurt eyes.
- Please don't disassemble the cap lamp, or it may cause potential troubles related to safety, reliability to work underground.
- Please don't crash and strike the lamp.
- Please don't charge the lamp underground.
- Please keep the lamp away from fire sources.

- Please don't maintain the lamp underground. All maintenance must be done on the ground!
- Please don't repair self-disassembly; otherwise the manufacturer will not be responsible for the warranty.
- Please recycle the discarded cap lamp together rather than throwing them away without disposing.

► PACKAGE

- The lamp and accessory is packed by color box package.
- Color box size: 165x96x66mm